

NEEDLE HOLDERS SUTURING INSTRUMENTS

NEEDLE HOLDERS

Nadelhalter | Porta-agujas
 Prote-aiguilles | Porta aghi



Mayo-Hegar
Needle Holders



08-101-12
12.5 cm
Serrated-
Grooved



08-102-14
14 cm
Serrated-
Grooved



08-103-16
16 cm
Serrated-
Grooved



08-104-18
18 cm
Serrated-
Grooved



08-105-20
20 cm
Serrated-
Grooved



08-106-24
24 cm
Serrated-
Grooved



08-107-26
26 cm
Serrated-
Grooved



08-108-30
30 cm
Serrated-
Grooved



08-109-12
12.5 cm
Serrated-
Grooved
Curved



08-110-14
14 cm
Serrated-
Grooved
Curved



08-111-16
16 cm
Serrated-
Grooved
Curved



08-112-18
18 cm
Serrated-
Grooved
Curved



08-113-20
20 cm
Serrated-
Grooved
Curved



08-114-24
24 cm
Serrated-
Grooved
Curved



08-115-26
26 cm
Serrated-
Grooved
Curved



08-116-30
30 cm
Serrated-
Grooved
Curved

KUMMAS
CORPORATION



08-117-12
12.5 cm
Serrated



08-118-14
14 cm
Serrated



08-119-16
16 cm
Serrated



08-120-18
18 cm
Serrated



08-121-20
20 cm
Serrated



08-122-24
24 cm
Serrated



08-123-26
26 cm
Serrated



08-124-30
30 cm
Serrated



08-125-12
12.5 cm
Serrated
Curved



08-126-14
14 cm
Serrated
Curved



08-127-16
16 cm
Serrated
Curved



08-128-18
18 cm
Serrated
Curved



08-129-20
20 cm
Serrated
Curved



08-130-24
24 cm
Serrated
Curved



08-131-26
26 cm
Serrated
Curved



08-132-30
30 cm
Serrated
Curved



Mayo-Hegar
Needle Holders

NEEDLE HOLDERS

Nadelhalter | Porta-agujas
Prote-aiguilles | Porta aghi

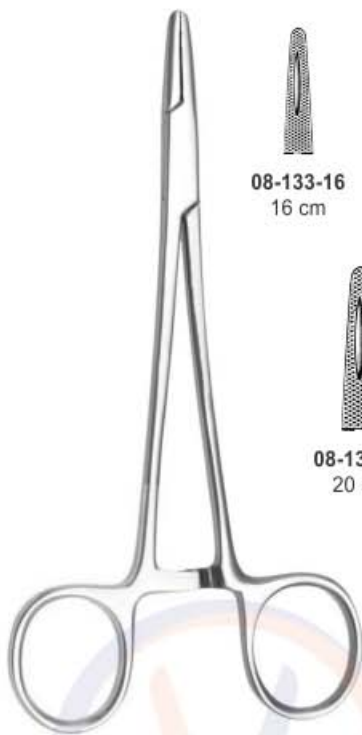

**Mayo-Hegar
Needle Holders**
Serrated-Grooved
left handed

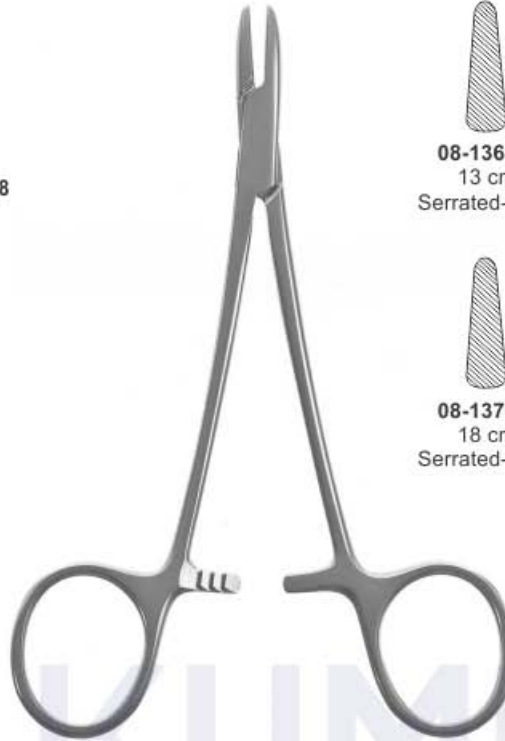
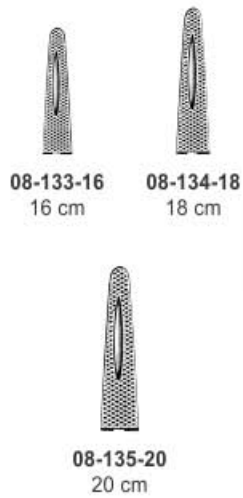

**Brown
Needle Holder**

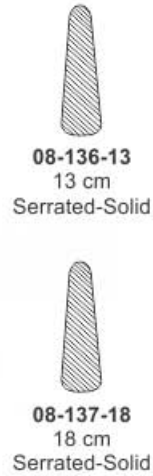

**Baby Crile-Wood
Needle Holder**

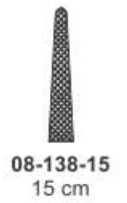

**Crile-Wood
Needle Holder**

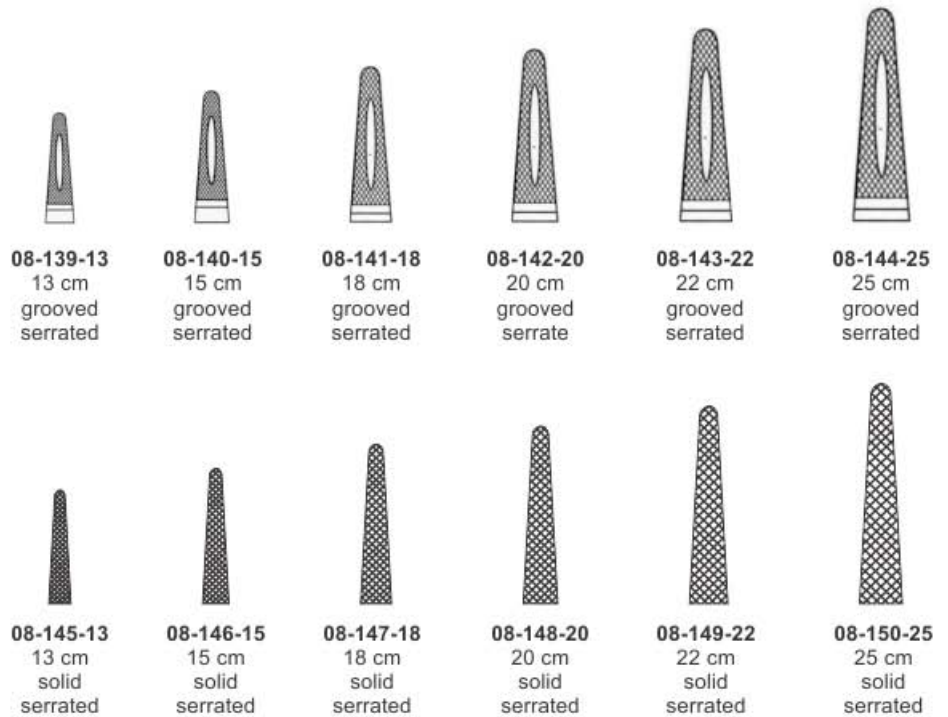

NEEDLE HOLDERS

Nadelhalter | Porta-agujas
 Prote-aiguilles | Porta aghi

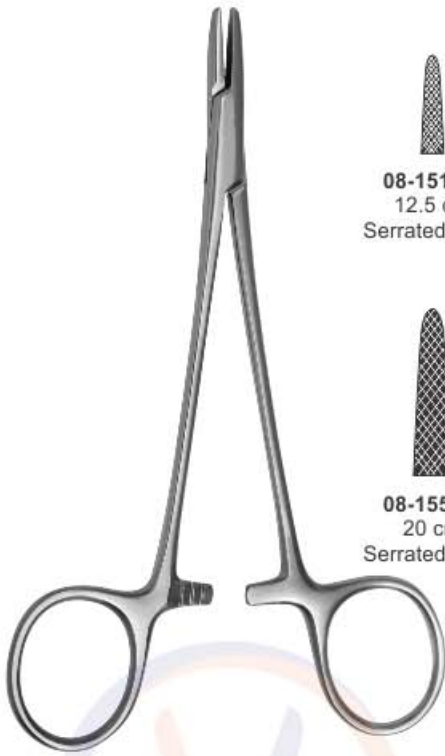

**Baumgartner
Needle Holder**

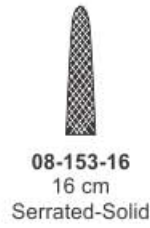
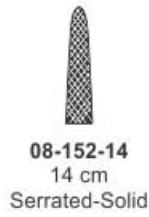

**Mass. General Hospital
Needle Holders**

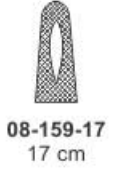

KUMMAS
CORPORATION



**Webster
Needle Holder**

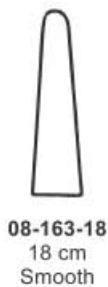
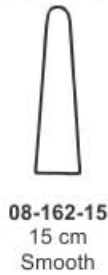
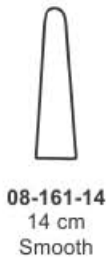

Adson Needle Holders



NEEDLE HOLDERS

Nadelhalter | Porta-agujas
Prote-aiguilles | Porta aghi

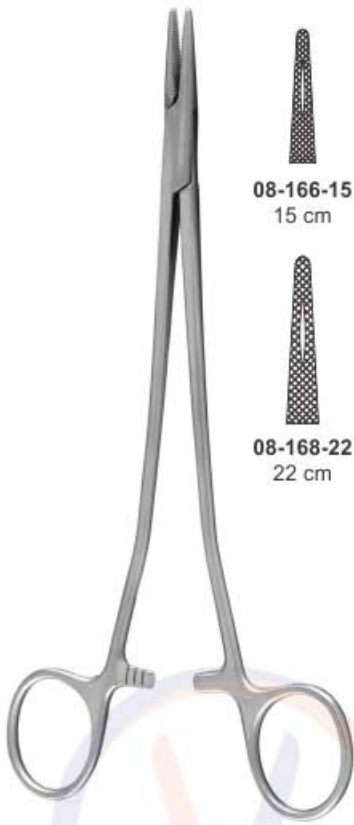

- 08-166-15
15 cm
- 08-167-18
18 cm
- 08-168-22
22 cm
- 08-169-26
26 cm

Sarot Needle Holders



- 08-170-20
20cm
- 08-171-23
23cm

Julian

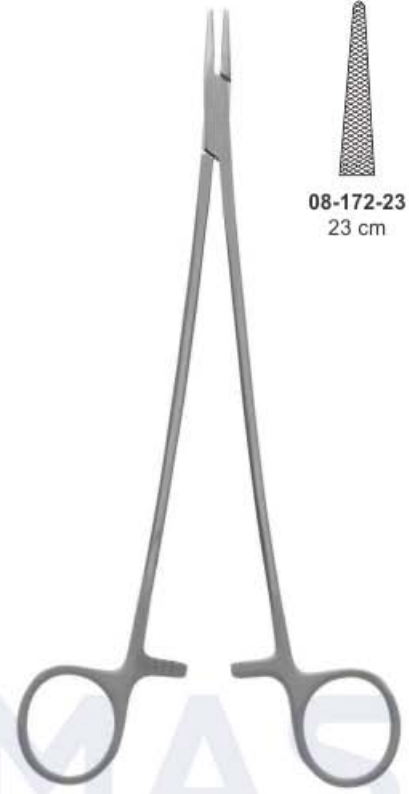

- 08-172-23
23 cm

Jameson Needle Holders



- 08-173-27
27 cm

Finocchietto Needle Holders



- 08-174-20
20 cm
Cvd.
- 08-175-27
27 cm
Cvd.

Heaney Needle Holders



- 08-176-18
18 cm

New Orleans Needle Holders

NEEDLE HOLDERS

Nadelhalter | Porta-agujas
 Prote-aiguilles | Porta aghi



08-177-13
13 cm
serrated

Kilner Needle Holders

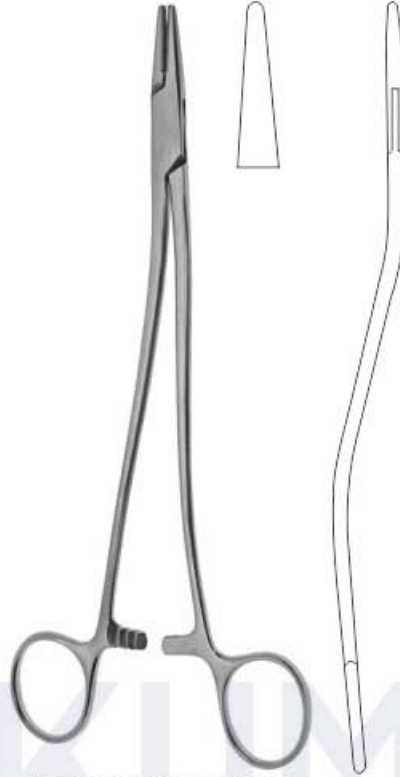

Wertheim Needle Holders
08-178-20 20 cm
08-179-24 24 cm

Wertheim Needle Holders

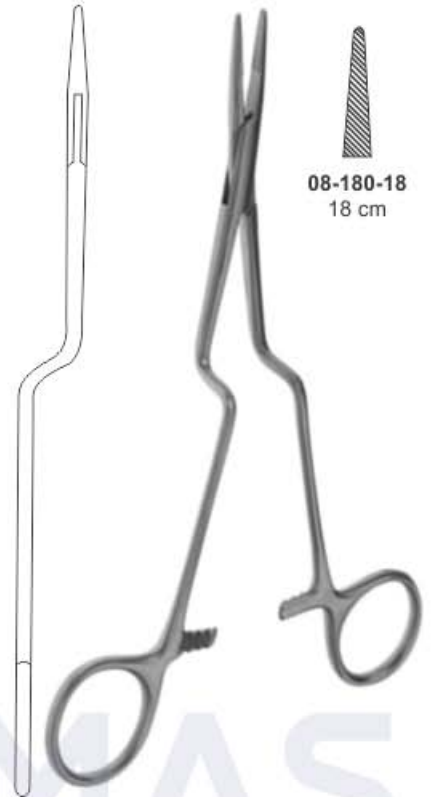

08-180-18
18 cm

Jacobson Needle Holders

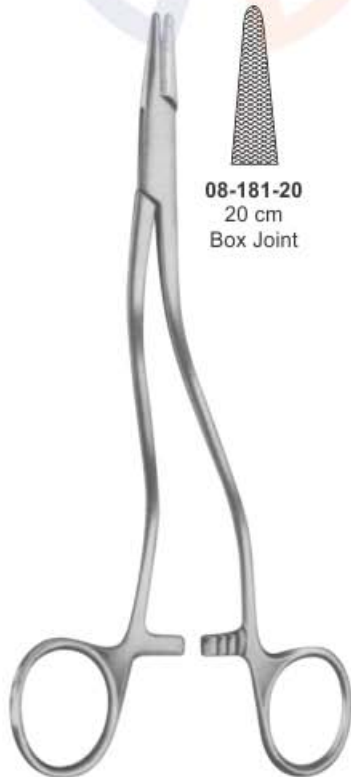

08-181-20
20 cm
Box Joint

**Thomson Walker
Needle Holders**

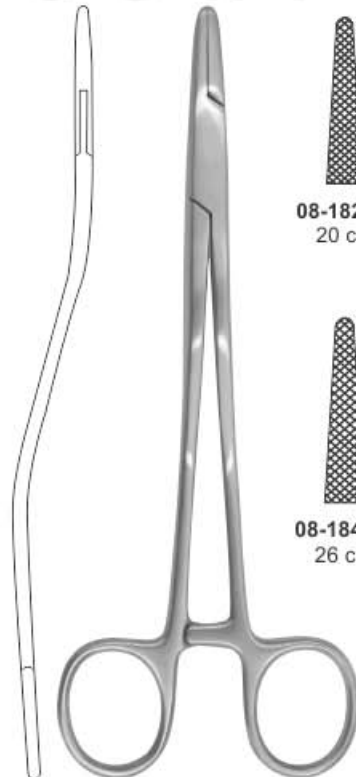

08-182-20
20 cm

08-184-26
26 cm

08-183-24
24 cm

08-185-30
30 cm

Bozemann Needle Holders

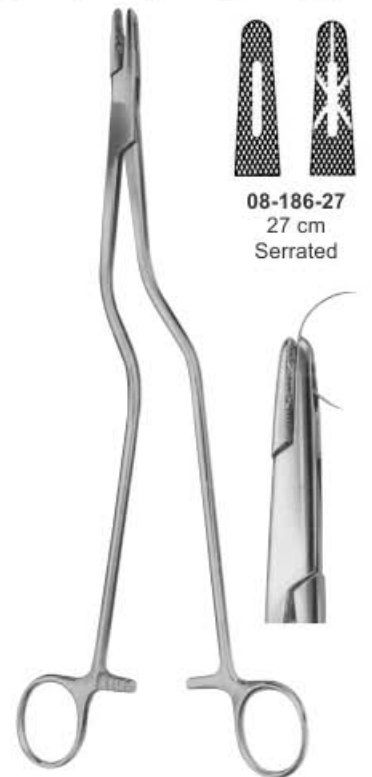

08-186-27
27 cm
Serrated

**Masson-Luethy
Needle Holders**

NEEDLE HOLDERS

Nadelhalter	Porta-agujas
Prote-aiguilles	Porta aghi



08-187-15
15 cm

08-188-17
17 cm

Senning Needle Holders
(Schwed. Model)

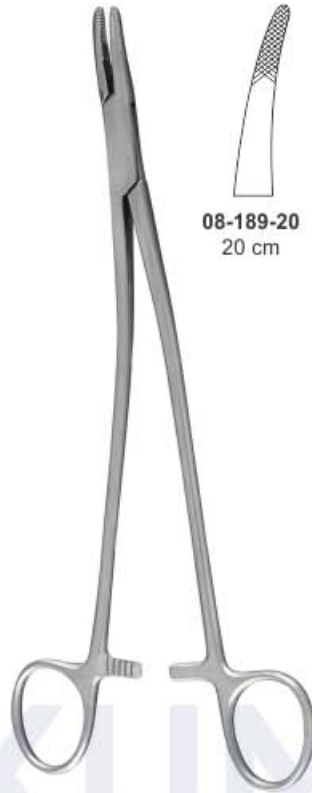

08-189-20
20 cm

08-190-23
23 cm

Stratte Needle Holders



08-191-18 18 cm
08-192-25 25 cm

Naunton Morgan Needle Holders
Compound Action Joint.

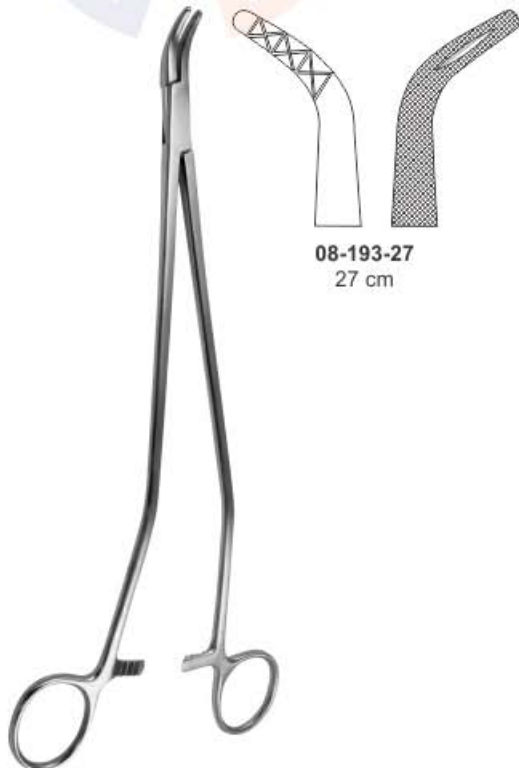

08-193-27
27 cm

Johnson Needle Holders



08-194-27
27 cm
Serrated-Solid

Wangensteen
Needle Holders



08-195-27
27 cm

Masson Needle Holder

NEEDLE HOLDERS

Nadelhalter | Porta-agujas
 Prote-aiguilles | Porta aghi

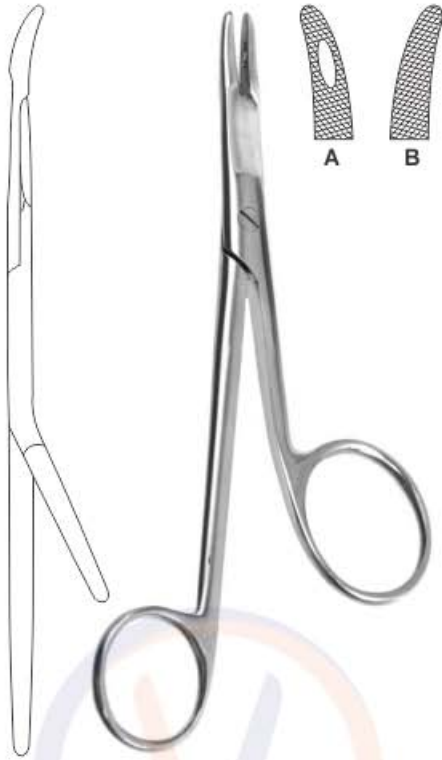

Gillies Needle Holders
 08-196-16 16 cm

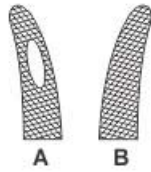

Olsen-Hegar Needle Holders

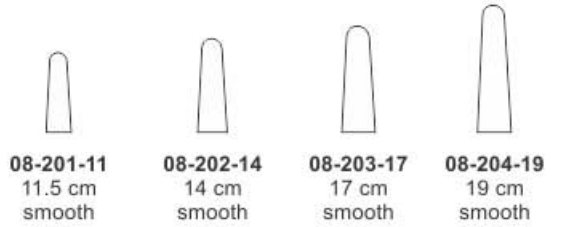
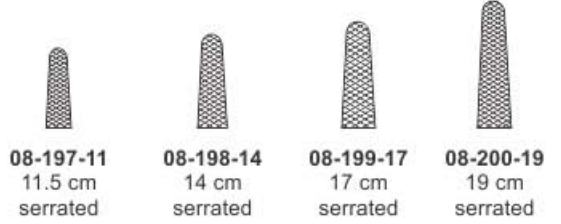

Halsey Needle Holders

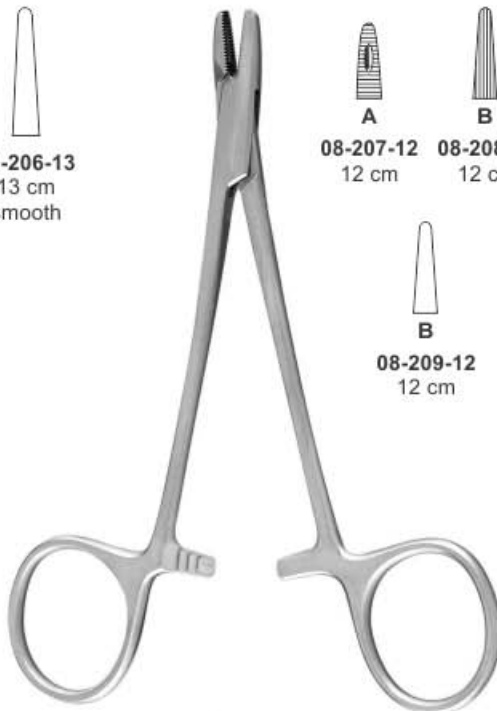
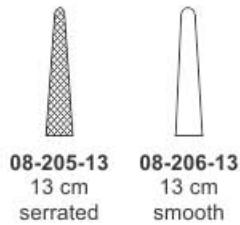

Derf Needle Holders

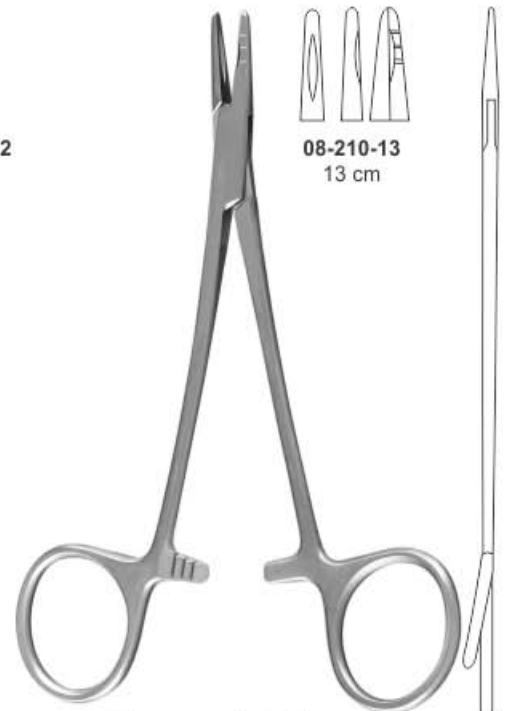
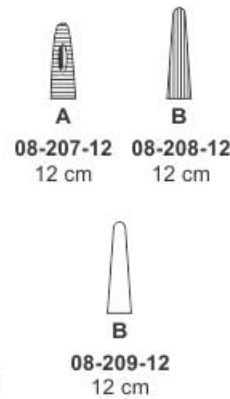

Neivert Needle Holders

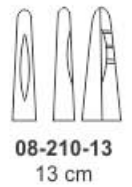

NEEDLE HOLDERS

Nadelhalter | Porta-agujas
Prote-aiguilles | Porta aghi



08-211-12
12.5 cm

Doyen Needle Holders



08-212-12
12.5 cm

Collier Needle Holders

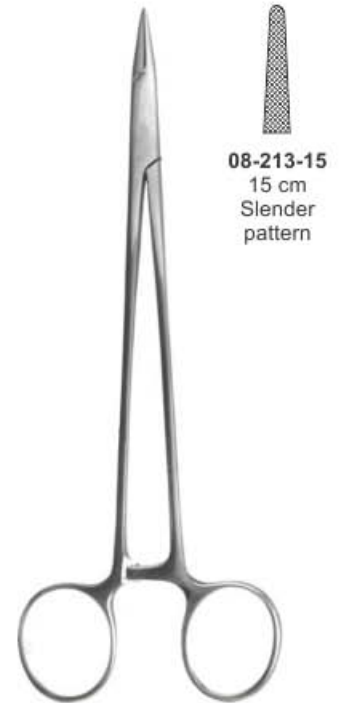

08-213-15
15 cm
Slender
pattern

**Crile-Murray
Needle Holders**



Derf-Converse
08-214-12
12.5cm



Converse
08-215-15
15cm



08-216-18
18.5 cm
One grooved and
fenestrated jaw

**Metzenbaum
Needle Holders**

NEEDLE HOLDERS

Nadelhalter | Porta-agujas
 Prote-aiguilles | Porta aghi



De Bakey Needle Holders
 08-217-18 18 cm
 08-218-20 20 cm
 08-219-22 22 cm
 08-220-25 25 cm



Intracardiac Needle Holders
 08-221-18 18 cm
 08-222-20 20 cm
 08-223-22 22 cm
 08-224-25 25 cm



Microvascular Needle Holders
 08-225-18 18 cm
 08-226-20 20 cm
 08-227-22 22 cm
 08-228-25 25 cm



Cooley Intracardiac Needle Holders
 Straight, narrow jaw.

08-229-18 18 cm
 08-230-20 20 cm

08-231-23 23 cm
 08-232-26 26 cm

C O R P O R A T I O N



Debakey Cardiovascular Needle Holders
 Delicate patterns.
 Straight jaw, serrated.

08-233-18 18 cm

08-234-23 23 cm

08-235-27 27 cm

08-236-30 30 cm



Finochietto Needle Holders
 08-237-13 13 cm
 08-238-16 16 cm
 08-239-19 19 cm
 08-240-21 21 cm



Finochietto Needle Holders
 08-241-13 13 cm Angled
 08-242-16 16 cm Angled
 08-243-19 19 cm Angled

NEEDLE HOLDERS

Nadelhalter | Porta-agujas
 Prote-aiguilles | Porta aghi



Ryder Needle Holders
Narrow jaws.



08-244-13
Narrow jaws
Smooth inserts.
13 cm



08-245-15
Narrow jaws
Smooth inserts.
15 cm



08-246-18
Narrow jaws
Smooth inserts.
18 cm



08-247-20
Narrow jaws
Smooth inserts.
20 cm



08-248-23
Narrow jaws
Smooth inserts.
23 cm



08-249-13
Narrow jaws
serrated
13 cm



08-250-15
Narrow jaws
serrated
15 cm



08-251-18
Narrow jaws
serrated
18 cm



08-252-20
Narrow jaws
serrated
20 cm



08-253-23
Narrow jaws
serrated
23 cm

KUMMAS
CORPORATION



Micro Ryder Needle Holders



08-254-15
15 cm



08-255-18
18 cm



08-256-20
20 cm



French-Eye Needle Holder

08-257-16 16 cm
08-258-18 18 cm
08-259-20 20 cm
08-260-22 22 cm
08-261-25 25 cm
 Narrow Tip



French-Eye Needle Holder

08-262-16 16 cm
08-263-18 18 cm
08-264-20 20 cm
08-265-22 22 cm



NEEDLE HOLDERS

Nadelhalter	Porta-agujas
Prote-aiguilles	Porta aghi



Mathieu Needle Holders

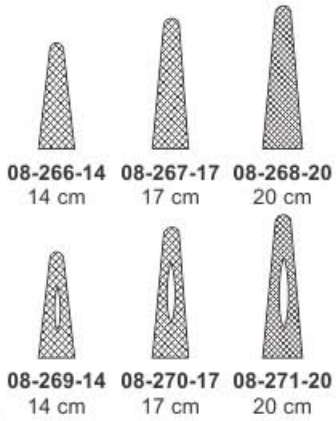

Mathieu Needle Holders

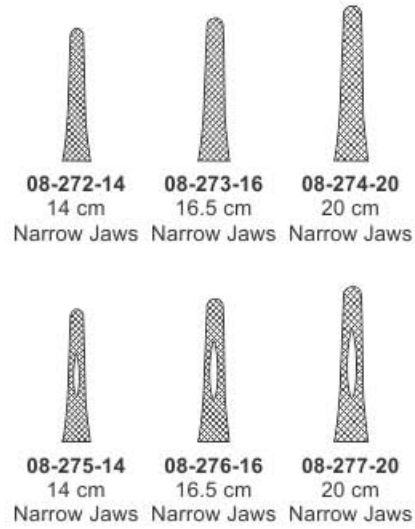

Mathieu Needle Holder
Joint Off Wise
08-278-14
14cm

KUMMAS CORPORATION



MATHIEU

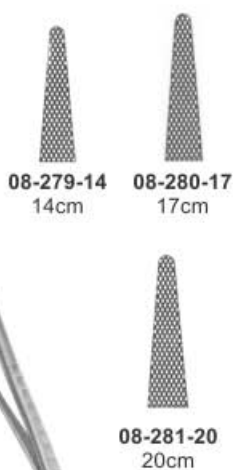

MATHIEU
with groove

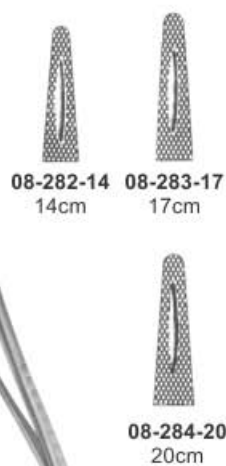

Crile Needle Holders

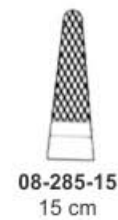

Toennis Needle Holders



NEEDLE HOLDERS

Nadelhalter
Prote-aiguilles

Porta-agujas
Porta aghi



**Mathieu
Screw-Joint**

**Mathieu
Screw-Joint
with groove**

Lichtenberg

**Eiselsberg-Mathieu
08-295-18
18.5cm**

for palate
suture

KUMMAS
CORPORATION

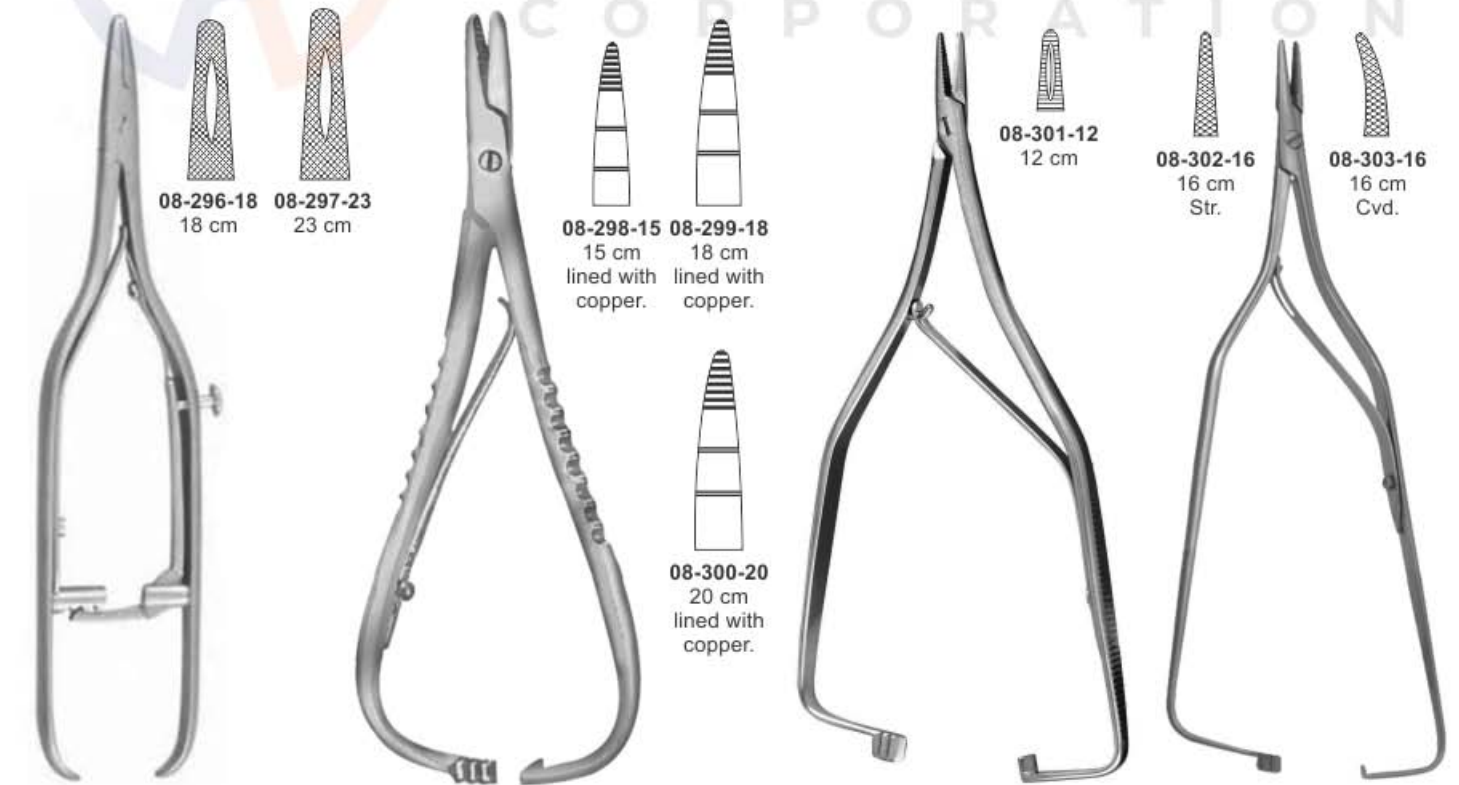

**Mayo Rochester
Needle Holders**
button release, screw joint.

Macphail Needle Holders

Boynton Needle Holders

Arruga Needle Holders

NEEDLE HOLDERS

Nadelhalter
Prote-aiguilles

Porta-agujas
Porta aghi



Potts-Smith
08-304-22
22cm



Stevens
08-305-15
15cm



08-306-14
14 cm
Serrated

Kalt Needle Holders



08-307-14
14 cm
Serrated
Str.

08-308-14
14 cm
Serrated
Cvd.

Arruga Needle Holders

KUMMAS
CORPORATION



Castroviejo Needle Holders

08-309-12
12 cm
Smooth Str
with lock

08-310-12
12 cm
Smooth Cvd
with lock



Barraquer-Troutman Needle Holders

08-311-10
10 cm
08-312-11
11.5 cm
Smooth
Str.

08-313-10
10 cm
08-314-11
11.5 cm
Smooth
Cvd.



Barraquer Micro Needle Holders
Smooth with lock

08-315-11
11 cm
08-316-13
13 cm
Straight

08-317-11
11 cm
08-318-13
13 cm
Curved



Barraquer Needle Holders
Smooth without lock

08-319-11
11 cm
08-320-13
13 cm
Straight

08-321-11
11 cm
08-322-13
13 cm
Curved

NEEDLE HOLDERS

Nadelhalter
Prote-aguilles

Porta-agujas
Porta aghi



**Castroviejo
Needle Holders**



08-323-14
14 cm
Straight
Smooth
with lock



08-324-14
14 cm
Curved
Smooth
with lock



08-325-14
14 cm
Straight
Smooth
without lock



08-326-14
14 cm
Curved
Smooth
without lock



08-331-10
10 cm
08-332-14
14 cm
Straight



08-333-10
10 cm
08-334-14
14 cm
Curved



08-327-18
18 cm
Straight
Smooth
with lock



08-328-18
18 cm
Curved
Smooth
with lock



08-329-18
18 cm
Straight
Smooth
without lock



08-330-18
18 cm
Curved
Smooth
without lock



**Troutman
Needle Holders**
Smooth without lock

KUMMAS
CORPORATION



Castroviejo Needle Holders



08-335-14
14 cm
with lock
straight



08-336-14
14 cm
with lock
curved



08-337-14
14 cm
without lock
straight



08-338-14
14 cm
without lock
curved



JACOBSON
08-339-18 without catch
08-340-18 with catch
18.5cm



08-341-20
straight



08-342-20
curved



YASARGIL
with catch
20cm



**Castroviejo Olsen Hegar /
Needle Holders / Scissors**



08-343-13
13 cm
08-344-15
15 cm

NEEDLE HOLDERS

Nadelhalter | Porta-agujas
 Prote-aiguilles | Porta aghi



Micro Needle Holder
08-345-15 15 cm
08-346-18 18 cm
08-347-21 21 cm
08-348-23 23 cm



Micro Needle Holder
 Straight, with catch
08-349-18
 18.5cm



Micro Needle Holder
 Curved, without catch
08-350-18
 18.5cm



08-351-19
 19 cm
08-352-23
 23 cm
 Smooth
 Str.



08-353-19
 19 cm
08-354-23
 23 cm
 Smooth
 Cvd.



08-355-16
 16 cm
 Smooth
 Cvd.



YASARGIL
08-356-16
 upwards curved
 16.5cm



YASARGIL
08-357-20
 straight
 20cm



YASARGIL
08-358-20
 upwards curved
 20cm



YASARGIL
08-359-22
 straight
 22.5cm



YASARGIL
08-360-22
 upwards curved
 22.5cm

NEEDLE HOLDERS

Nadelhalter
Prote-aiguilles

Porta-agujas
Porta aghi

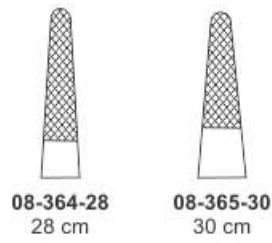
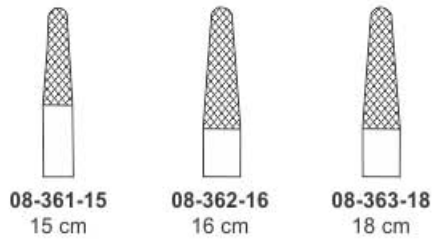
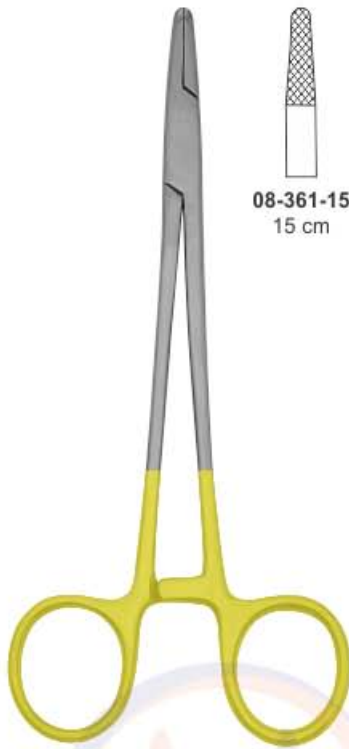

Mayo-Hegar Needle Holders T.C

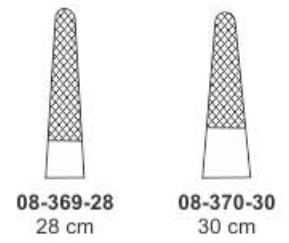
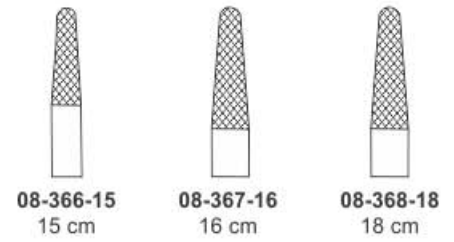

Mayo-Hegar Needle Holders T.C
Left handed.

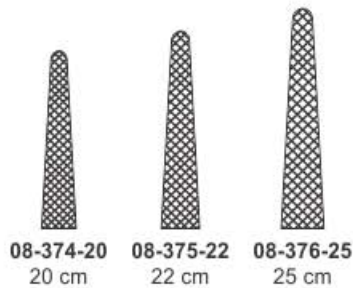
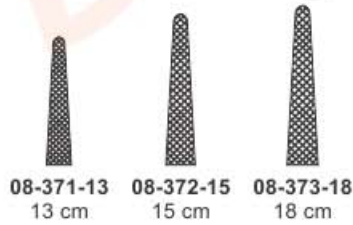

Crile-Wood Needle Holders T.C.

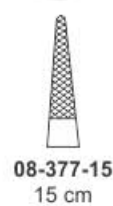

Baby Crile-Wood Needle Holders T.C

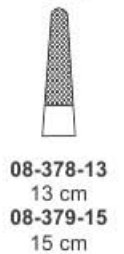
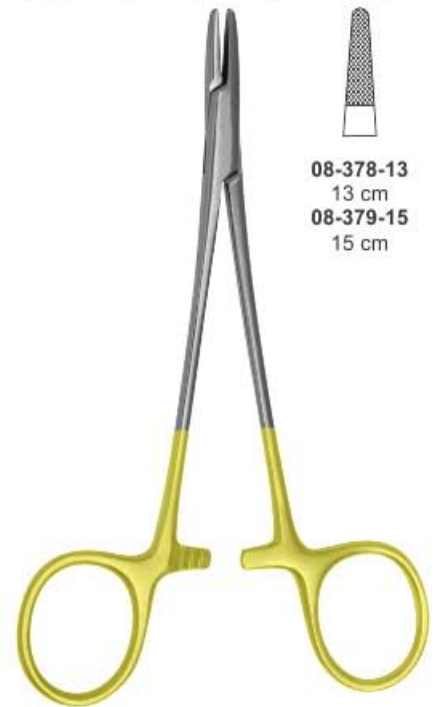

Baumgartner Needle Holders T.C

NEEDLE HOLDERS

Nadelhalter
Prote-aiguilles

Porta-agujas
Porta aghi



08-380-12
12.5 cm

Converse Needle Holders

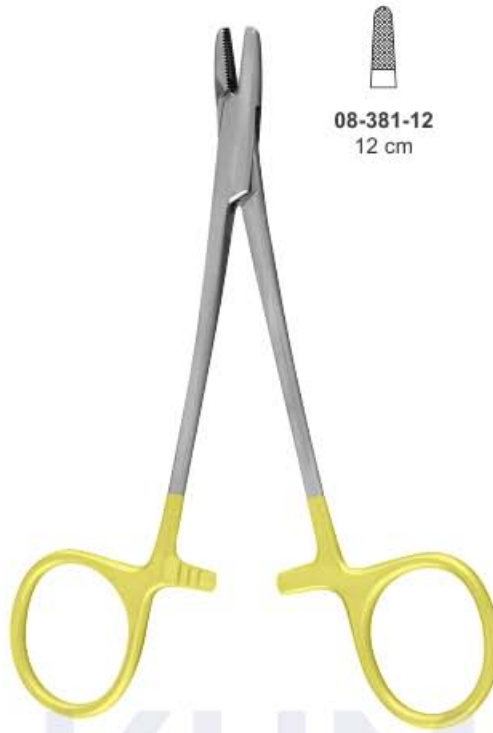

08-381-12
12 cm

Derf Needle Holders T.C



08-382-13
13 cm

Kilner Needle Holders T.C

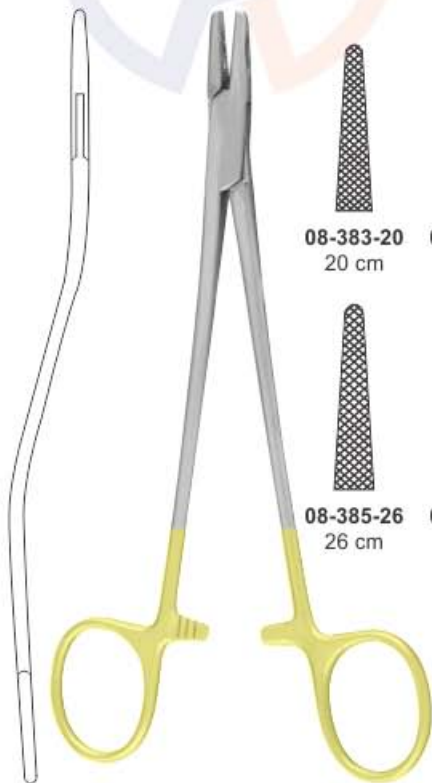

08-383-20
20 cm

08-384-24
24 cm

08-385-26
26 cm

08-386-30
30 cm

Bozemann Needle Holders T.C

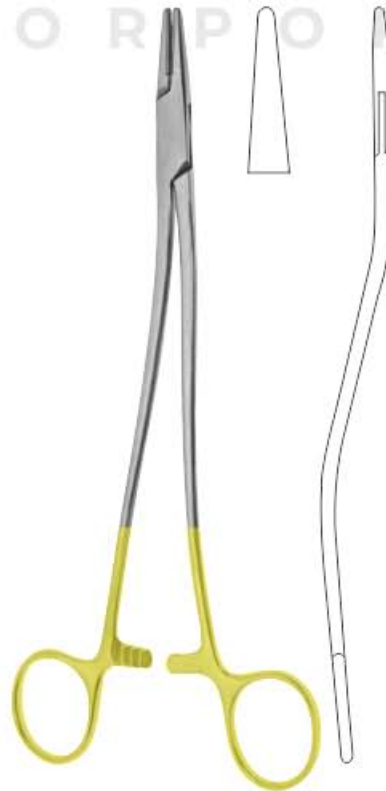

Wertheim Needle Holders T.C
08-387-20 20 cm
08-388-24 24 cm



Thomson-Walker Needle Holders T.C
08-389-20 20 cm
08-390-25 25 cm

NEEDLE HOLDERS

Nadelhalter	Porta-agujas
Prote-aiguilles	Porta aghi

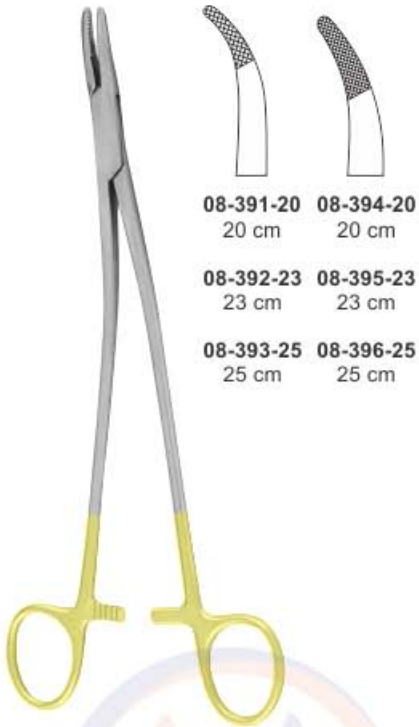

08-391-20 20 cm	08-394-20 20 cm
08-392-23 23 cm	08-395-23 23 cm
08-393-25 25 cm	08-396-25 25 cm

Stratte Needle Holders T.C



08-397-12 12.5 cm Smooth	08-398-12 12.5 cm Serrated
---------------------------------------	---

Halsey Needle Holders T.C



08-399-18
18 cm

Rochester Needle Holders T.C

KUMMAS
CORPORATION



Converse "HM"
08-400-15
15cm



08-401-15
15 cm

Carroll Needle Holders T.C.



08-402-14
14 cm
Delicate

Eufrate Pasque T.C
Needle Holders

NEEDLE HOLDERS

Nadelhalter | Porta-agujas
 Prote-aiguilles | Porta aghi



Olsen-Hegar Needle Holders T.C

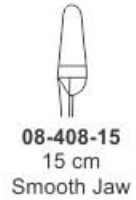

Gillies Needle Holders T.C

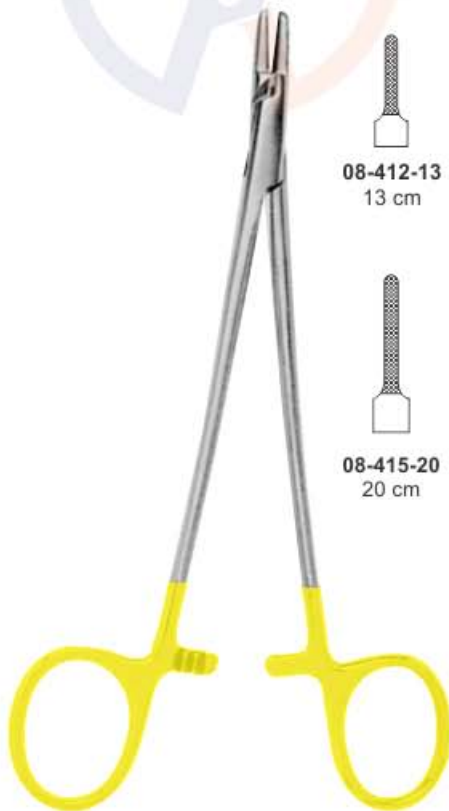

Ryder French-Eye/Standard
Needle Holders T.C

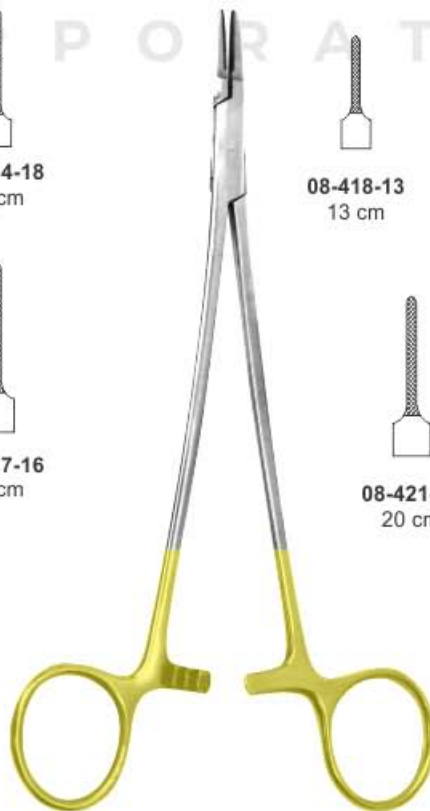
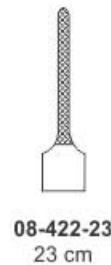
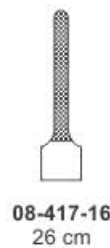
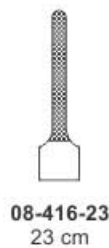
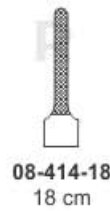
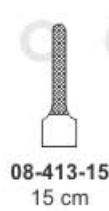

Micro Ryder Needle
Holders T.C.
Delicate

NEEDLE HOLDERS

Nadelhalter | Porta-agujas
 Prote-aiguilles | Porta aghi

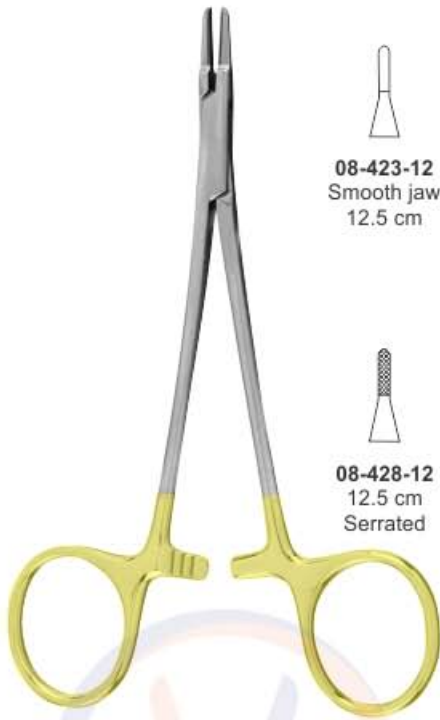

Ryder Needle Holders T.C.
Narrow jaws.



08-423-12
Smooth jaw
12.5 cm



08-424-15
Smooth jaw
15 cm



08-425-18
Smooth jaw
18 cm



08-426-20
Smooth jaw
20 cm



08-427-23
Smooth jaw
23 cm



08-433-18
18 cm
08-434-20
20 cm



08-428-12
12.5 cm
Serrated



08-429-15
15 cm
Serrated



08-430-18
18 cm
Serrated



08-431-20
20 cm
Serrated



08-432-23
23 cm
Serrated



08-435-23
23 cm
08-436-26
26 cm

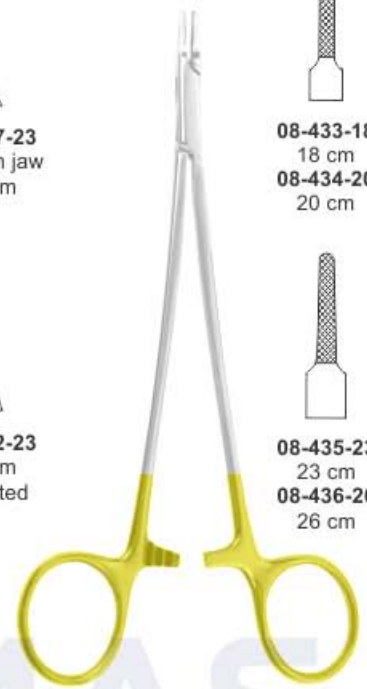

Cooley Intracardiac Needle Holders T.C.
Narrow Jaw.

KUMMAS
CORPORATION

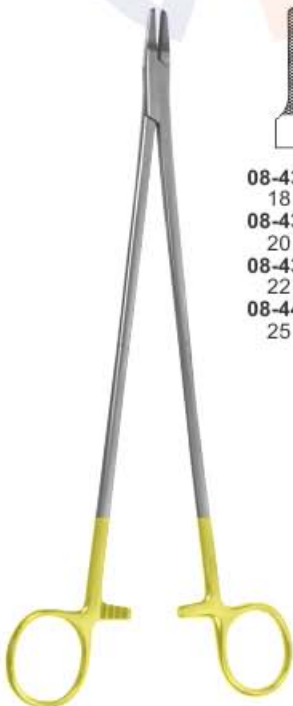

Intracardiac Needle Holders T.C.



08-437-18
18 cm
08-438-20
20 cm
08-439-22
22 cm
08-440-25
25 cm

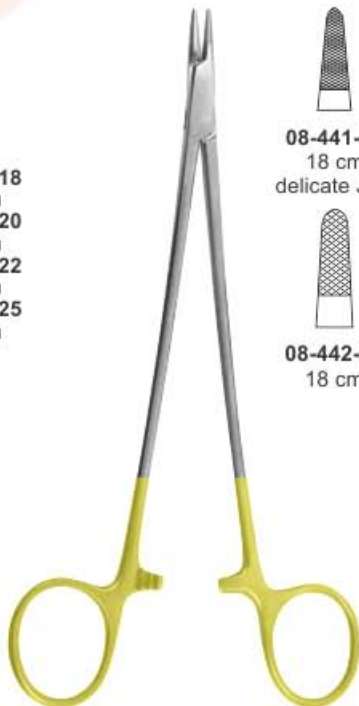

New Orleans Needle Holders T.C.



08-441-18
18 cm
delicate Jaw



08-442-18
18 cm

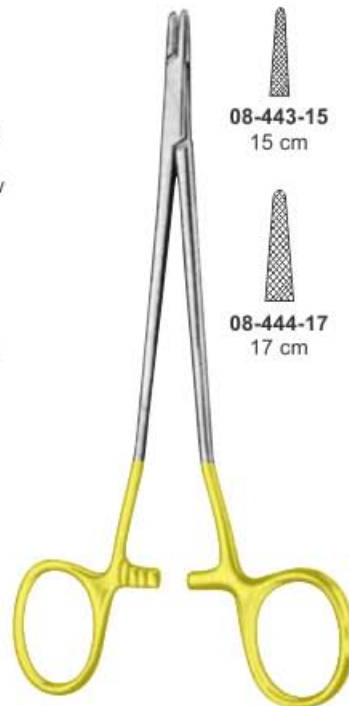

Senning Needle Holders T.C.
(Schwed. Model)



08-443-15
15 cm



08-444-17
17 cm

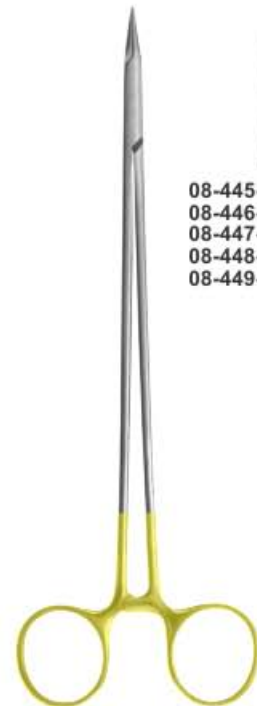



Microvascular Needle Holders T.C.



08-445-14 14 cm
08-446-18 18 cm
08-447-20 20 cm
08-448-23 23 cm
08-449-25 25 cm

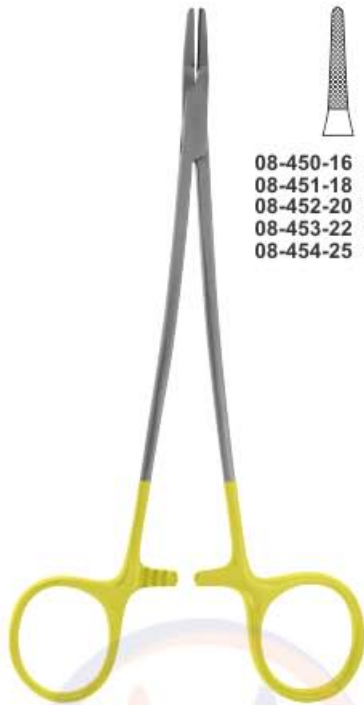

NEEDLE HOLDERS

Nadelhalter	Porta-agujas
Prote-aiguilles	Porta aghi

08-450-16 16 cm
08-451-18 18 cm
08-452-20 20 cm
08-453-22 22 cm
08-454-25 25 cm

French-Eye Needle Holders T.C

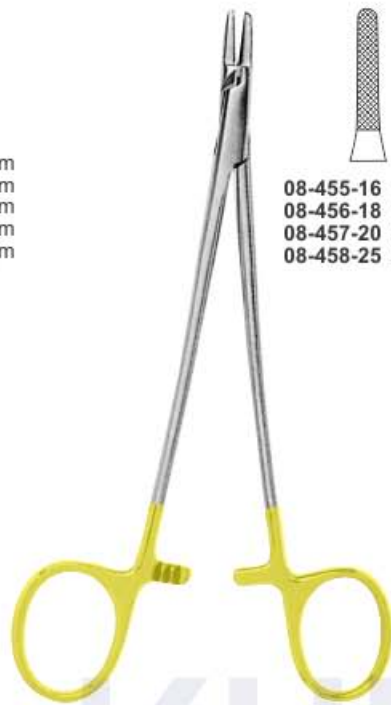
08-455-16 16 cm
08-456-18 18 cm
08-457-20 20 cm
08-458-25 25 cm

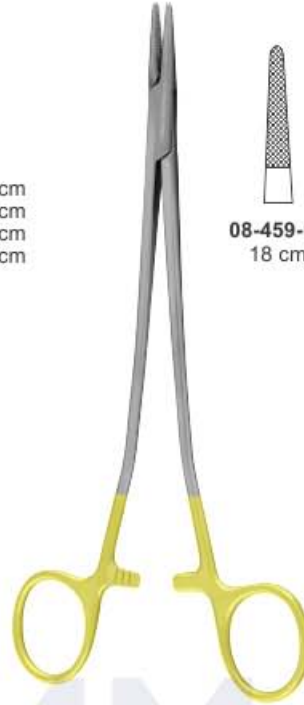
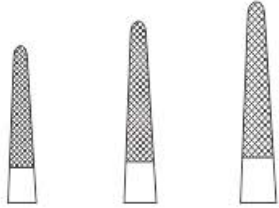

French-Eye Needle Holders T.C

08-459-18 18 cm
08-460-20 20 cm
08-461-26 26 cm

Sartot Needle Holders T.C

KUMMAS
CORPORATION

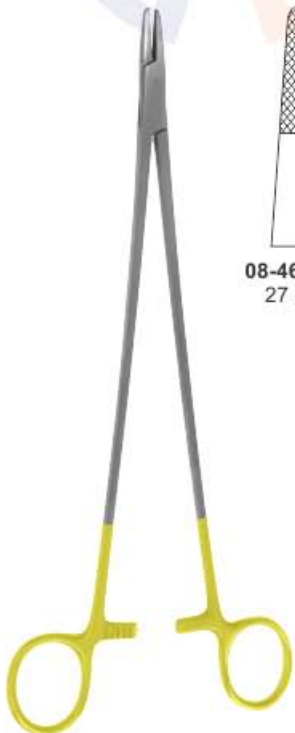

08-462-27
27 cm

Wangensteen Needle Holders T.C

08-463-13 13 cm
08-464-16 16 cm
08-465-19 19 cm
08-466-21 21 cm

Finochietto Needle Holders T.C

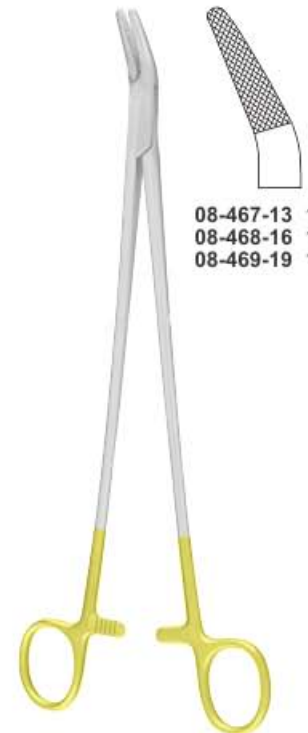



08-467-13 13 cm
08-468-16 16 cm
08-469-19 19 cm

Finochietto Needle Holders T.C

NEEDLE HOLDERS

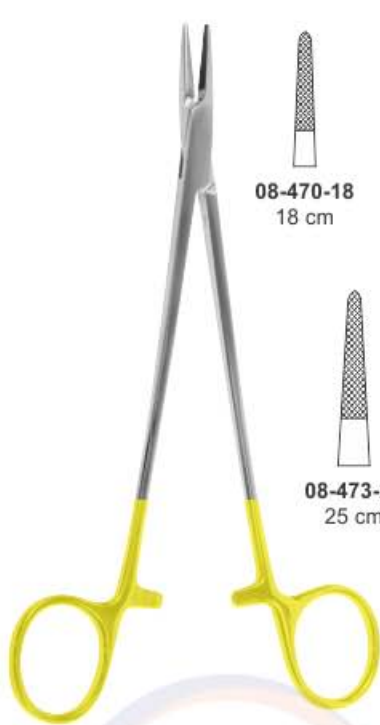
Nadelhalter | Porta-agujas
 Prote-aiguilles | Porta aghi



- 08-470-18
18 cm
- 08-471-20
20 cm
- 08-472-22
22 cm
- 08-473-25
25 cm
- 08-474-31
31 cm

De Bakey Needle Holders T.C

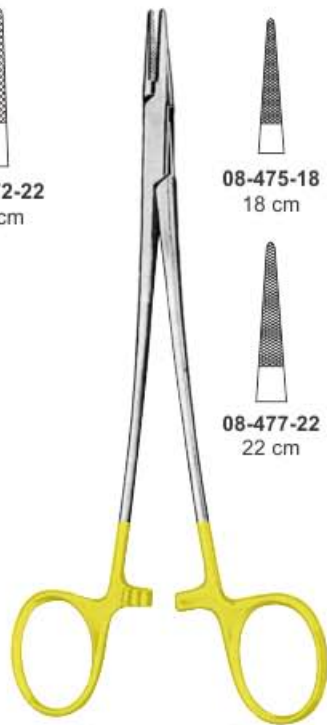

- 08-475-18
18 cm
- 08-476-20
20 cm
- 08-477-22
22 cm
- 08-478-25
25 cm

Debakey-Vascular
 Extra delicate
 Needle Holders T.C

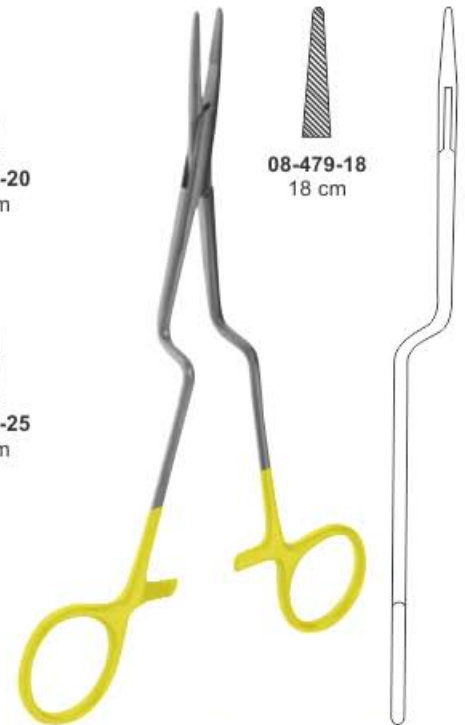

- 08-479-18
18 cm

Jacobson Needle Holders T.C



- 08-480-13
13 cm
Smooth
- 08-481-15
15 cm
Smooth
- 08-482-13
13 cm
Serrated
- 08-483-15
15 cm
Serrated

Webster Needle Holders T.C

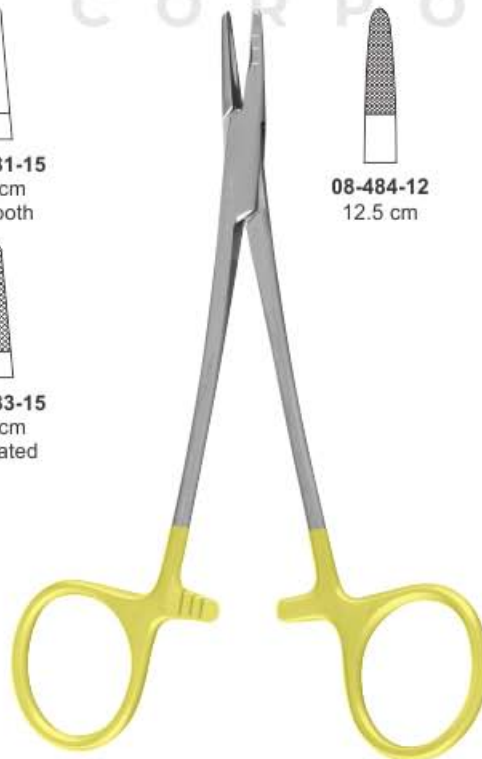

- 08-484-12
12.5 cm

Neivert Needle Holders T.C



- 08-485-21
21 cm
- 08-486-24
24 cm
- 08-487-26
26 cm

Heaney-Gyne Needle Holders T.C
 Curved

NEEDLE HOLDERS

Nadelhalter	Porta-agujas
Prote-aiguilles	Porta aghi



Julian Needle Holders T.C



Masson Needle Holders T.C



O'Brien Needle Holders T.C



Martin
Needle Holder mini profile elastic type

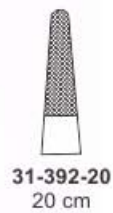

Cooley-Baumgaften Wire Twister Needle Holders T.C
Extra heavy needle holder designed for twisting of wire and placement of retention suture. Heavy, blunt jaws.

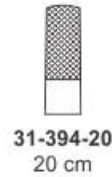

Wire Tightening Needle Holders T.C
31-396-18 18 cm

NEEDLE HOLDERS

Nadelhalter | Porta-agujas
 Prote-aguilles | Porta aghi



08-488-15 15 cm
 Delicate

08-489-15 15 cm
 08-490-18 18 cm
 08-491-20 20 cm
 Heavy

Wire Twisters Needle Holders T.C



08-492-12 12.5 cm

Rubio Wire Twister
 Needle Holders T.C



08-493-18 18 cm

Sternum Needle Holders T.C
 Wire Twister



Mathieu Needle Holder
 08-494-17 17 cm
 08-495-20 20 cm
 08-496-23 23 cm



Mathieu Needle Holder
 08-497-14 14 cm
 08-498-17 17 cm
 08-499-20 20 cm



Mathieu Needle Holder
 08-500-14 14 cm
 08-501-17 17 cm
 08-502-20 20 cm
 Delicate



08-503-17 17 cm
 08-504-20 20 cm

Mathieu-Ryder Needle
 Holders T.C

08-505-24 24 cm



08-506-17 17 cm
 08-507-20 20 cm

Mathieu-Ryder Vascular
 Needle Holders T.C
 Delicate

08-508-24 24 cm



08-509-20 20 cm

Lichtenberg
 Needle Holders T.C

NEEDLE HOLDERS

Nadelhalter
Prote-aiguilles

Porta-agujas
Porta aghi

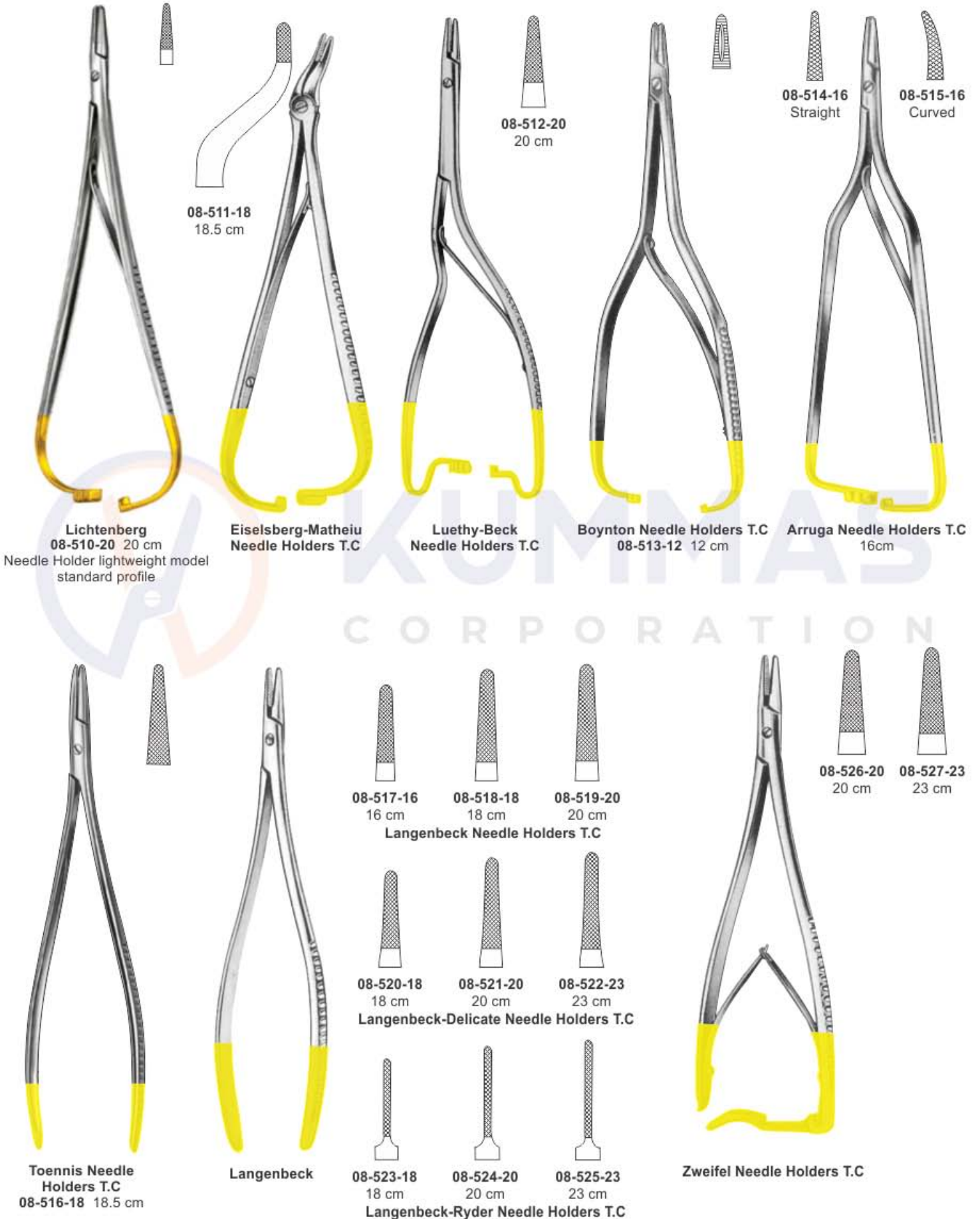

NEEDLE HOLDERS

Nadelhalter	Porta-agujas
Prote-aiguilles	Porta aghi



Kalt Needle Holders T.C
08-528-14 14 cm
Straight



08-529-15
15 cm



08-530-15
15 cm



08-531-17
17 cm

Corwin Needle Holders T.C



Castroviejo
08-532-12
Micro Needle Holder
12.5 cm



Hepp-Scheidel
08-533-18
Micro Needle Holder smooth jaw
18 cm



Barraquer
Micro Needle Holder
08-534-13
13 cm



Barraquer
Micro Needle Holder
08-535-13
13 cm



Jaboma
Micro Needle Holder
08-536-18
18 cm



Spencer Coronary
Needle Holders T.C
08-537-18 18 cm

NEEDLE HOLDERS

Nadelhalter
Prote-aiguilles

Porta-agujas
Porta aghi

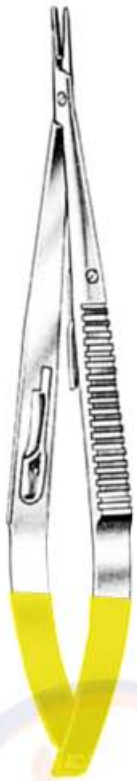

Castroviejo Needle Holders T.C



08-538-14
14 cm
Straight
Smooth
fine tip



08-539-14
14 cm
Curved
Smooth
fine tip



08-540-14
14 cm
Straight
Serrated
fine tip



08-541-14
14 cm
Straight
Smooth
standard tip



08-542-14
14 cm
08-543-18
18 cm
Straight
Serrated
standard tip



08-544-14
14 cm
08-545-18
18 cm
Curved
Serrated
standard tip



Castroviejo Needle Holders T.C

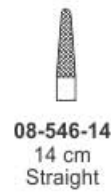

08-546-14
14 cm
Straight



08-547-14
14 cm
Curved



Castroviejo Micro Needle Holder
08-548-14 14.5 cm
08-549-18 18 cm
08-550-21 21.5 cm



Castroviejo Needle Holders T.C



08-551-18
18 cm



08-552-22
22 cm



Jacobson Needle Holders T.C



08-553-18
18 cm
Smooth

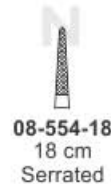

08-554-18
18 cm
Serrated



08-555-21
21 cm
Smooth



08-556-21
21 cm
Serrated



08-557-01
14.5 cm



08-558-02
14.5 cm



08-559-03
14.5 cm



08-560-04
14.5 cm

Reverdin Needle
short



Reverdin Needle
19.5 cm



08-561-01
19.5cm
08-565-01
23cm



08-562-02
19.5cm
08-566-02
23cm



08-563-03
19.5cm
08-567-03
23cm



08-564-04
19.5cm
08-568-04
23cm



Reverdin Needle
23 cm

KUMMAS
CORPORATION

REVERDIN NEEDLES, LIGATURE NEEDLE

Reverdin-Nadeln, Ligaturnadel
Aiguilles Reverdin, Aiguille à Ligature

Agujas de Reverdin, Aguja de ligadura
Aghi Reverdin, ago per legatura

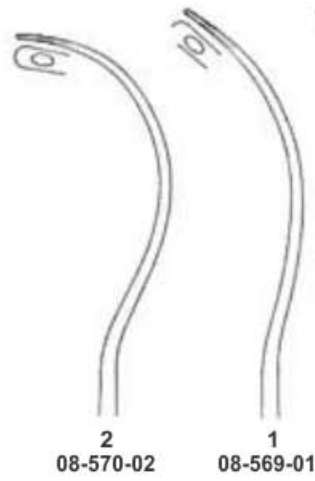

21cm



08-573-25
25cm



08-574-23
23cm
08-575-28
28cm

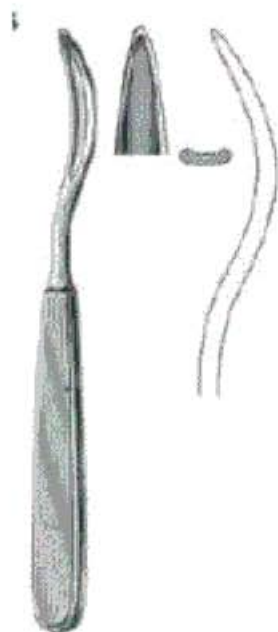

Konig
08-576-20
20 cm



Payr
08-577-22
22 cm



Konig Ligature Conductor
08-578-19
19.5cm / 3 mm



Michel Clip Applying Forceps
08-579-12
12cm



Young Needle
08-580-00
24.5 cm
Complete with on
Needle no. 00
01, 02,03



08-581-01
Needle No. 01



08-582-02
Needle No. 02



08-583-03
Needle No. 03

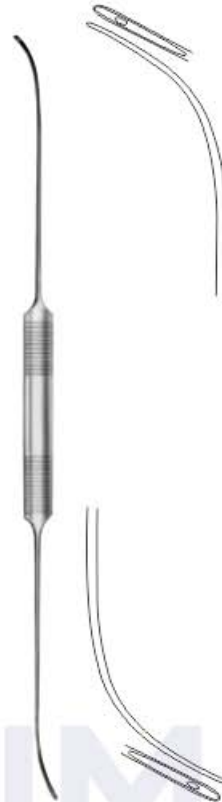

Schmieden-Dick Needle
08-584-29 29cm
malleable



Schmieden Needle
08-585-24 24cm

KUMMAS
CORPORATION



Ligature Needle
08-586-20
20 cm



Cooper Needle
08-587-19
19 cm



Kronecker Needle
08-588-13
13 cm
delicate
for right hand



Kronecker Needle
08-589-13
13 cm
delicate
for left hand



Deschamps Needle
08-590-24
24 cm



Deschamps Needle
08-591-24
24 cm

Curved to left,
for the right
hand

Curved to right,
for the left
hand

LIGATUTR NEEDLES

Unterbindungsnadeln
aguja para ligaduras

Aiguilles à ligatures
aghi di legatura



Deschamps Needle
08-592-20 20cm sharp for right hand
08-593-20 20cm sharp for left hand



Deschamps Needle
08-594-20 20cm blunt for right hand
08-595-20 20cm blunt for left hand

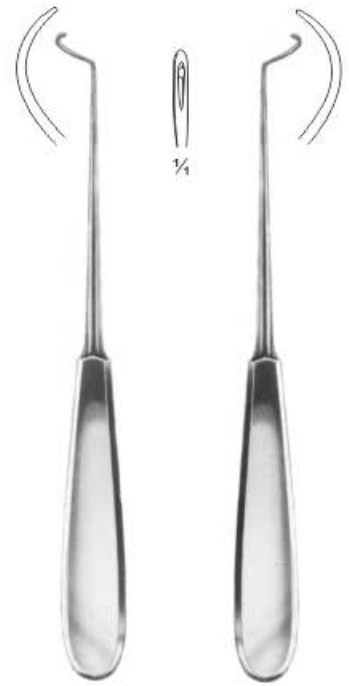

Deschamps Needle
08-596-21 21cm blunt for right hand
08-597-21 21cm blunt for left hand

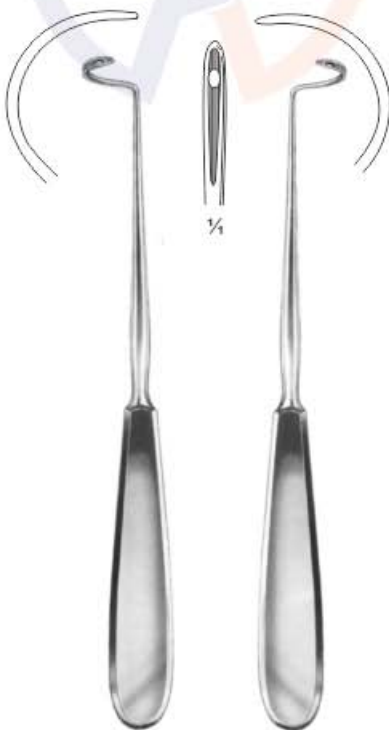

Deschamps Needle
08-598-20 20cm blunt for right hand
08-599-20 20cm blunt for left hand



Deschamps Needle
08-600-20 20cm sharp for right hand
08-601-20 20cm sharp for left hand

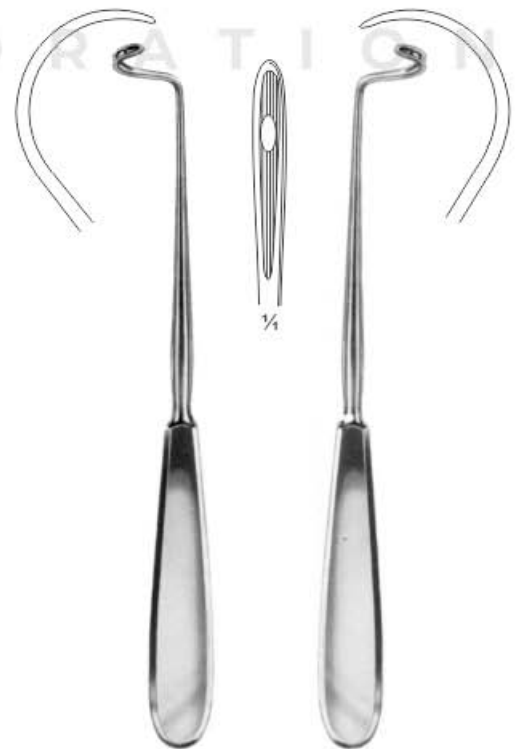

Deschamps Needle
08-602-20 20cm blunt for right hand
08-603-20 20cm blunt for left hand



Deschamps Needle
08-604-20 08-605-20
20cm 20cm
sharp sharp
for right for left
hand hand

Deschamps Needle
08-606-27 08-607-27
27cm 27cm
blunt blunt
for right for left
hand hand

Deschamps Needle
08-608-27 08-609-27
27cm 27cm
sharp sharp
for right for left
hand hand

Deschamps Needle
08-610-28 08-611-28
28cm 28cm
blunt blunt
for right for left
hand hand

SURGEONS NEEDLES FISTULA

- 08-612-00 Fistula Needle, 1/2 Circle, Cutting Edge, #00
- 08-613-00 Fistula Needle, 1/2 Circle, Cutting Edge, #0
- 08-614-01 Fistula Needle, 1/2 Circle, Cutting Edge, #1
- 08-615-02 Fistula Needle, 1/2 Circle, Cutting Edge, #2
- 08-616-03 Fistula Needle, 1/2 Circle, Cutting Edge, #3
- 08-617-04 Fistula Needle, 1/2 Circle, Cutting Edge, #4
- 08-618-05 Fistula Needle, 1/2 Circle, Cutting Edge, #5
- 08-619-06 Fistula Needle, 1/2 Circle, Cutting Edge, #6
- 08-620-07 Fistula Needle, 1/2 Circle, Cutting Edge, #7
- 08-621-08 Fistula Needle, 1/2 Circle, Cutting Edge, #8
- 08-622-09 Fistula Needle, 1/2 Circle, Cutting Edge, #9

1/2 Circle - Cutting Edge



SURGEONS NEEDLES REGULAR

- 08-623-0 Regular Surgeons Needle, 1/2 Circle, Cutting Edge, #0
- 08-624-01 Regular Surgeons Needle, 1/2 Circle, Cutting Edge, #1
- 08-625-02 Regular Surgeons Needle, 1/2 Circle, Cutting Edge, #2
- 08-626-03 Regular Surgeons Needle, 1/2 Circle, Cutting Edge, #3
- 08-627-04 Regular Surgeons Needle, 1/2 Circle, Cutting Edge, #4
- 08-628-05 Regular Surgeons Needle, 1/2 Circle, Cutting Edge, #5
- 08-629-06 Regular Surgeons Needle, 1/2 Circle, Cutting Edge, #6
- 08-630-07 Regular Surgeons Needle, 1/2 Circle, Cutting Edge, #7
- 08-631-08 Regular Surgeons Needle, 1/2 Circle, Cutting Edge, #8
- 08-632-09 Regular Surgeons Needle, 1/2 Circle, Cutting Edge, #9
- 08-633-10 Regular Surgeons Needle, 1/2 Circle, Cutting Edge, #10
- 08-634-11 Regular Surgeons Needle, 1/2 Circle, Cutting Edge, #11
- 08-635-12 Regular Surgeons Needle, 1/2 Circle, Cutting Edge, #12
- 08-636-13 Regular Surgeons Needle, 1/2 Circle, Cutting Edge, #13
- 08-637-14 Regular Surgeons Needle, 1/2 Circle, Cutting Edge, #14
- 08-638-15 Regular Surgeons Needle, 1/2 Circle, Cutting Edge, #15
- 08-639-16 Regular Surgeons Needle, 1/2 Circle, Cutting Edge, #16
- 08-640-17 Regular Surgeons Needle, 1/2 Circle, Cutting Edge, #17
- 08-641-18 Regular Surgeons Needle, 1/2 Circle, Cutting Edge, #18
- 08-642-19 Regular Surgeons Needle, 1/2 Circle, Cutting Edge, #19
- 08-643-20 Regular Surgeons Needle, 1/2 Circle, Cutting Edge, #20

1/2 Circle - Cutting Edge



SURGEONS NEEDLES REGULAR

- 08-644-01 Regular Surgeons Needle, 3/8 Circle, Cutting Edge, #1
- 08-645-02 Regular Surgeons Needle, 3/8 Circle, Cutting Edge, #2
- 08-646-03 Regular Surgeons Needle, 3/8 Circle, Cutting Edge, #3
- 08-647-04 Regular Surgeons Needle, 3/8 Circle, Cutting Edge, #4
- 08-648-05 Regular Surgeons Needle, 3/8 Circle, Cutting Edge, #5
- 08-649-06 Regular Surgeons Needle, 3/8 Circle, Cutting Edge, #6
- 08-650-07 Regular Surgeons Needle, 3/8 Circle, Cutting Edge, #7
- 08-651-08 Regular Surgeons Needle, 3/8 Circle, Cutting Edge, #8
- 08-652-09 Regular Surgeons Needle, 3/8 Circle, Cutting Edge, #9
- 08-653-10 Regular Surgeons Needle, 3/8 Circle, Cutting Edge, #10
- 08-654-11 Regular Surgeons Needle, 3/8 Circle, Cutting Edge, #11
- 08-655-12 Regular Surgeons Needle, 3/8 Circle, Cutting Edge, #12
- 08-656-13 Regular Surgeons Needle, 3/8 Circle, Cutting Edge, #13
- 08-657-14 Regular Surgeons Needle, 3/8 Circle, Cutting Edge, #14
- 08-658-15 Regular Surgeons Needle, 3/8 Circle, Cutting Edge, #15
- 08-659-16 Regular Surgeons Needle, 3/8 Circle, Cutting Edge, #16
- 08-660-17 Regular Surgeons Needle, 3/8 Circle, Cutting Edge, #17
- 08-661-18 Regular Surgeons Needle, 3/8 Circle, Cutting Edge, #18
- 08-662-19 Regular Surgeons Needle, 3/8 Circle, Cutting Edge, #19
- 08-663-20 Regular Surgeons Needle, 3/8 Circle, Cutting Edge, #20

3/8 Circle - Cutting Edge



Keith Abdominal Straight, Triangular Point

- 08-664-01** Keith Abdominal Needles, Straight, Triangular Point, 4"
- 08-665-02** Keith Abdominal Needles, Straight, Triangular Point, 3-1/2"
- 08-666-03** Keith Abdominal Needles, Straight, Triangular Point, 3"
- 08-667-04** Keith Abdominal Needles, Straight, Triangular Point, 2-7/8"
- 08-668-05** Keith Abdominal Needles, Straight, Triangular Point, 2-1/8"
- 08-669-06** Keith Abdominal Needles, Straight, Triangular Point, 2"
- 08-670-07** Keith Abdominal Needles, Straight, Triangular Point, 1-3/4"
- 08-671-08** Keith Abdominal Needles, Straight, Triangular Point, 1-1/2"



SURGEONS NEEDLES REGULAR

- 08-672-00** Regular Surgeons Needles, 1/2 Curved, Cutting Edge, #0
- 08-673-01** Regular Surgeons Needles, 1/2 Curved, Cutting Edge, #1
- 08-674-02** Regular Surgeons Needles, 1/2 Curved, Cutting Edge, #2
- 08-675-04** Regular Surgeons Needles, 1/2 Curved, Cutting Edge, #4
- 08-676-06** Regular Surgeons Needles, 1/2 Curved, Cutting Edge, #6
- 08-677-08** Regular Surgeons Needles, 1/2 Curved, Cutting Edge, #8
- 08-678-10** Regular Surgeons Needles, 1/2 Curved, Cutting Edge, #10
- 08-679-12** Regular Surgeons Needles, 1/2 Curved, Cutting Edge, #12
- 08-680-14** Regular Surgeons Needles, 1/2 Curved, Cutting Edge, #14
- 08-681-16** Regular Surgeons Needles, 1/2 Curved, Cutting Edge, #16
- 08-682-20** Regular Surgeons Needles, 1/2 Curved, Cutting Edge, #20
- 08-683-22** Regular Surgeons Needles, 1/2 Curved, Cutting Edge, #22

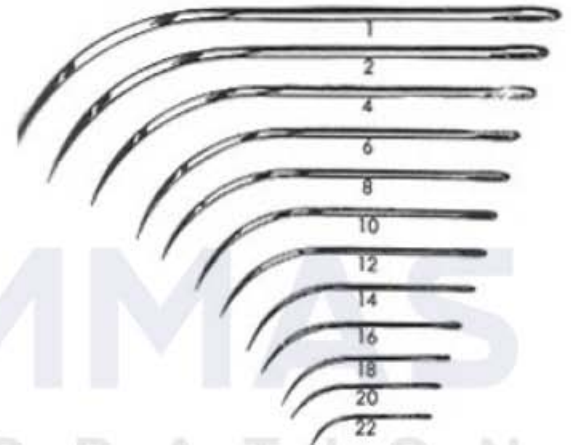

half Curved - Cutting Edge

SURGEONS NEEDLES REGULAR

- 08-684-02** Regular Surgeons Needles, 1/2 Curved, Tapered Point, #2
- 08-685-04** Regular Surgeons Needles, 1/2 Curved, Tapered Point, #4
- 08-686-06** Regular Surgeons Needles, 1/2 Curved, Tapered Point, #6
- 08-687-08** Regular Surgeons Needles, 1/2 Curved, Tapered Point, #8
- 08-688-10** Regular Surgeons Needles, 1/2 Curved, Tapered Point, #10
- 08-689-12** Regular Surgeons Needles, 1/2 Curved, Tapered Point, #12
- 08-690-14** Regular Surgeons Needles, 1/2 Curved, Tapered Point, #14
- 08-691-16** Regular Surgeons Needles, 1/2 Curved, Tapered Point, #16
- 08-692-18** Regular Surgeons Needles, 1/2 Curved, Tapered Point, #18
- 08-693-20** Regular Surgeons Needles, 1/2 Curved, Tapered Point, #20
- 08-694-22** Regular Surgeons Needles, 1/2 Curved, Tapered Point, #22

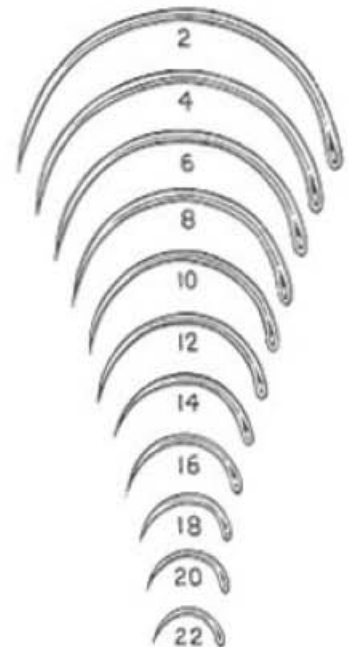

1/2 circle - Tapered Point

SURGEONS NEEDLES

- A** 08-695-01 Veterinary Needles, 3/8 Circle, Cutting Edge, #1
 08-696-02 Veterinary Needles, 3/8 Circle, Cutting Edge, #2
 08-697-03 Veterinary Needles, 3/8 Circle, Cutting Edge, #3
 08-698-04 Veterinary Needles, 3/8 Circle, Cutting Edge, #4
 08-699-05 Veterinary Needles, 3/8 Circle, Cutting Edge, #5
 08-700-06 Veterinary Needles, 3/8 Circle, Cutting Edge, #6
 08-701-07 Veterinary Needles, 3/8 Circle, Cutting Edge, #7
 08-702-08 Veterinary Needles, 3/8 Circle, Cutting Edge, #8

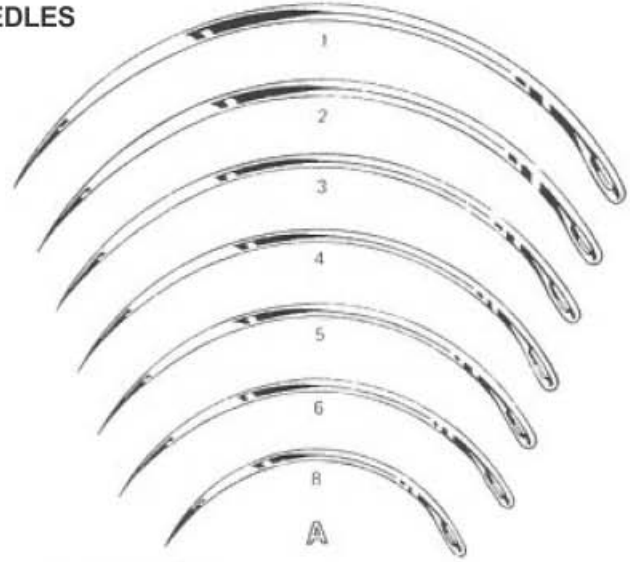

3/8 circle - cutting edge



KUMMAS
CORPORATION

- B** 08-703-01 Post Mortem Needles, Double Curve Cutting Edge, Size 1
 08-704-02 Post Mortem Needles, Double Curve Cutting Edge, Size 2
 08-705-03 Post Mortem Needles, Double Curve Cutting Edge, Size 3
 08-706-04 Post Mortem Needles, Double Curve Cutting Edge, Size 4
 08-707-05 Post Mortem Needles, Double Curve Cutting Edge, Size 5
 08-708-06 Post Mortem Needles, Double Curve Cutting Edge, Size 6
 08-709-07 Post Mortem Needles, Double Curve Cutting Edge, Size 7
 08-710-08 Post Mortem Needles, Double Curve Cutting Edge, Size 8

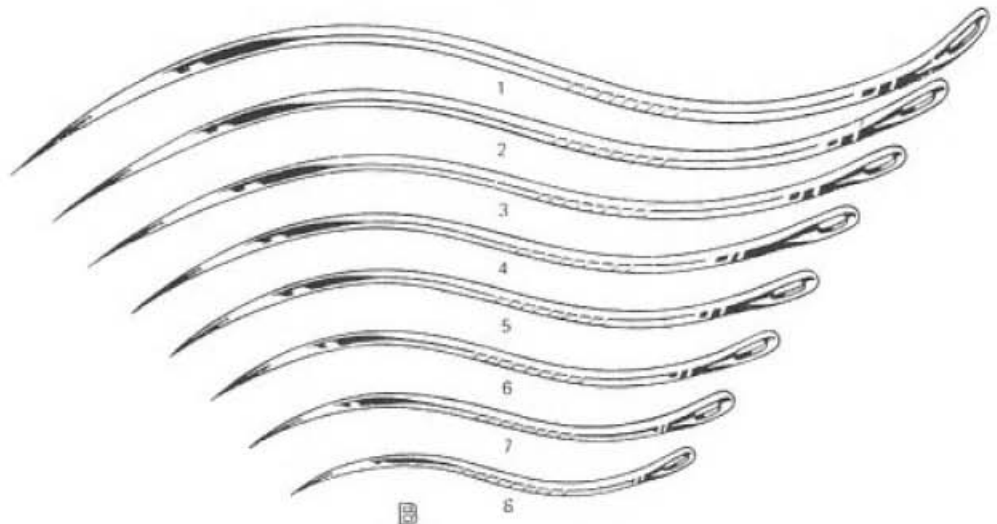

double curved - cutting edge

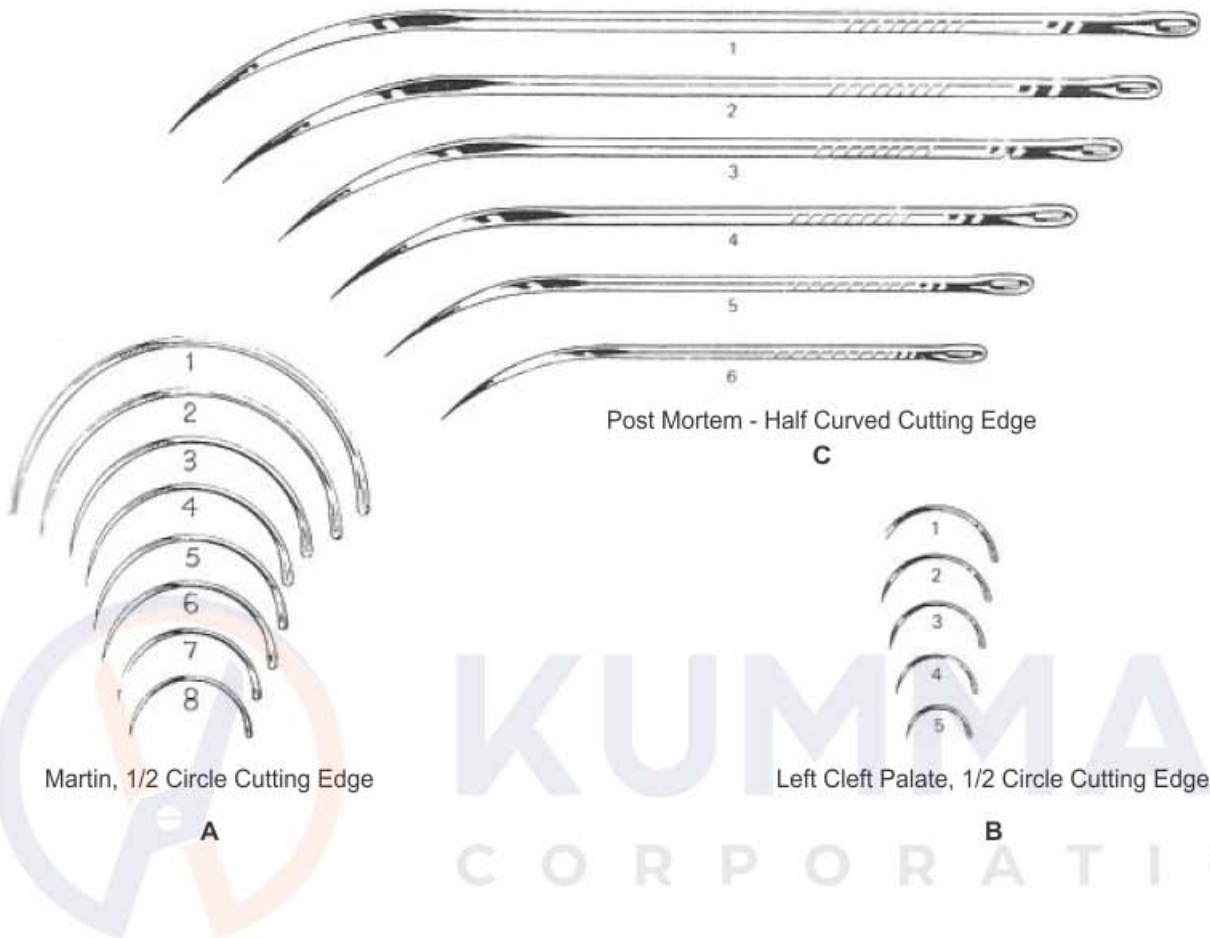

SURGEONS NEEDLES

- A** 08-711-01 Martin Uterine Needles, 1/2 Curved Cutting Edge, #1
 08-712-02 Martin Uterine Needles, 1/2 Curved Cutting Edge, #2
 08-713-03 Martin Uterine Needles, 1/2 Curved Cutting Edge, #3
 08-714-04 Martin Uterine Needles, 1/2 Curved Cutting Edge, #4
 08-715-05 Martin Uterine Needles, 1/2 Curved Cutting Edge, #5
 08-716-06 Martin Uterine Needles, 1/2 Curved Cutting Edge, #6
 08-717-07 Martin Uterine Needles, 1/2 Curved Cutting Edge, #7
 08-718-08 Martin Uterine Needles, 1/2 Curved Cutting Edge, #8
- B** 08-719-01 Lane Cleft Palate, 1/2 Circle, Cutting Edge, #1
 08-720-02 Lane Cleft Palate, 1/2 Circle, Cutting Edge, #2
 08-721-03 Lane Cleft Palate, 1/2 Circle, Cutting Edge, #3
 08-722-04 Lane Cleft Palate, 1/2 Circle, Cutting Edge, #4
 08-723-05 Lane Cleft Palate, 1/2 Circle, Cutting Edge, #5
- C** 08-724-01 Post Mortem Needles, Half Curved Cutting Edge, Size 1
 08-725-02 Post Mortem Needles, Half Curved Cutting Edge, Size 2
 08-726-03 Post Mortem Needles, Half Curved Cutting Edge, Size 3
 08-727-04 Post Mortem Needles, Half Curved Cutting Edge, Size 4
 08-728-05 Post Mortem Needles, Half Curved Cutting Edge, Size 5
 08-729-06 Post Mortem Needles, Half Curved Cutting Edge, Size 6



08-730-00

08-732-01
Ultra Suture practice pad
27 wounds
3 Layers
with and without mesh
Size: 7 1/2" X 5 1/2"
Weight: 200 Grams

08-731-01
"Suture practice pad with
plastic bottom case"



08-733-01
Neurosuture practice pad
20 wounds
3 Layers
with mesh
Size: 7" X 5"
Weight: 180 Grams

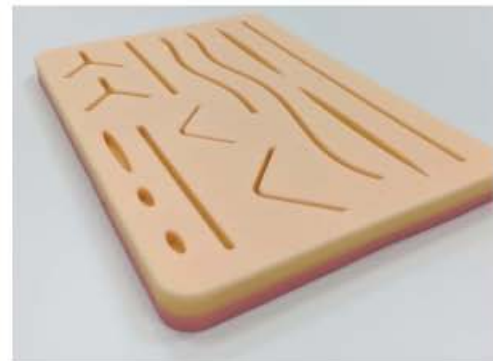

08-734-01
Regular Suture Practice Pad
14 Wounds
3 Layers
with Mesh
Size: 7" X 5"
Weight: 180 Grams